



WHT-6000 Round Thermostat

User Guide



For Warmset electric Heating

Welcome

Thank you for your purchase.

Your new thermostat will provide uniform and comfortable temperature control throughout every room in your property. We bring together technology, craftsmanship and the highest quality materials to provide you with a safe, reliable product combined with sleek, contemporary design.

Please read this installation/programming manual for comprehensive instructions on installing and operating your thermostat. Please also ensure a suitably qualified person installs your thermostat and complies with all local regulations.

In the box you will find

Thermostat	1pc	Screws	2pc
User Guide	1pc	Floor Sensor (2.5m)	1pc
QC Passed	1pc	(Floor sensor is Optional)	

ABOUT YOUR THERMOSTATS

HT- 6000 range has been developed to control electric underfloor ,water heating or water/gas boiler systems.These units are designed for use in commercial, industrial, civil and domestic properties

MODEL DEFINITION

- GA: Water heating, 3A
 - GB: Electric floor Heating, 16A
 - GC: Water/Gas Boiler, 3A
 - L: Backlight
 - P: Weekly Programmable
 - N: Modbus Communication
 - W: Wifi
 - S2: Both internal sensor and floor external sensor
- For example: 6000 GCLW**

FEATURES

On Appearance

- Negative black screen will bring you to a secret world.
- 51mm round display area helps to protect your eyes.
- Glass or Acrylic Lens is for your selection.
- Touch buttons to make simple operation.
- Amazing Silver Frame opens your modern life.
- The visible thickness above the wall is only 11mm.
- Rotation to connect gives you easy installation.
- 86mm hidden box and European 60mm round box is suitable.
- White, black or gold housing creates your colorful life.

On Functionality

- Powerful functions are available such as Modbus/WIFI etc,
- 0.5°C Accuracy keeps temperature within the level you set.
- Data memory when power is off.
- 5+2 six periods programmable maximize comfort and economy.
- Create thermostat group to Centralize control
- Interated with **Amazon Echo ,Google Home , Tmall Genie .**
- All setting languages synchronize your time zone, address and language.
- No limit to add rooms and support Smart Scene.

DIMENSION

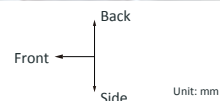

TECHNICAL DATA

Power Supply: 95 ~ 240 VAC, 50 ~ 60HZ
 Current Load : 3A (water heating/water boiler/gas boiler)
 16A (electric heating)

Sensor: NTC3950, 10K
 Accuracy: ±0.5 °C or ±1 °F
 Set Temp. Range: 5 ~ 35°C
 Display Temp. Range: 5 ~ 99 °C
 Ambient Temp.: 0 ~ 45 °C
 Ambient Humidity: 5 ~ 95 % RH (Non Condensing)
 Storage Temp.: -5 ~ 45 °C
 Power Consumption: <1.5W
 Timing Error: < 1%
 Shell Material: PC +ABS (Fireproof)
 Installation Box: 86 * 86mm Square or European 60mm Round Box
 Wire Terminals: Wire 2 x 1.5 mm2 or 1 x 2.5 mm2
 Protection Class: IP 20
 Buttons:Capactive Touch Buttons

BEFORE WIRING AND INSTALLING

- Read these instructions carefully. Failure to follow them could damage the product or cause a hazardous condition.
- Check the ratings given in the instructions and on the product to make sure the product is suitable for your application.
- Installer must be a trained, experienced service technician.
- After installation is complete, check out product operation as provided in these instructions.



CAUTION

Electrical Shock or Equipment Damage Hazard. Can shock individuals or short equipment circuitry.

Disconnect power supply before installation.

WIRING

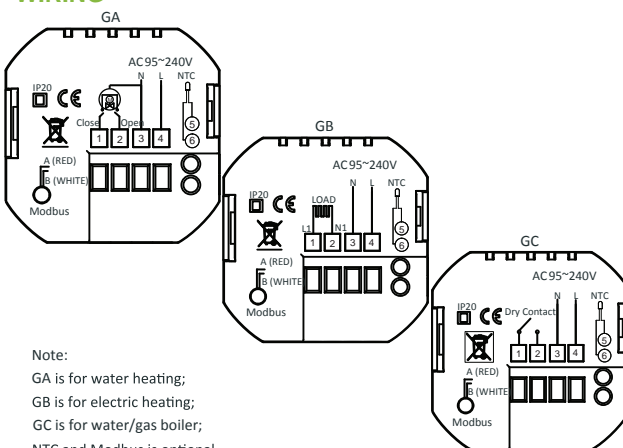

INSTALLATION

Your thermostat is suitable for installation within a standard 86mm pattress box or European 60mm pattress box.

Step 1. Keep power off. See Fig 1.

Step 2. Remove the mounting Plate by rotating the LCD part. See Fig 2.

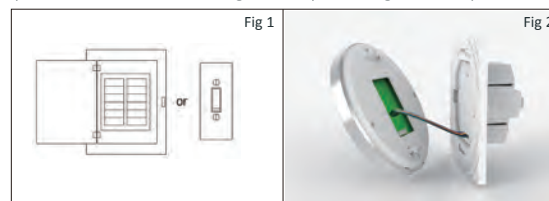

Step 3. Connect power supply, load into the appropriate terminals. (see "Wiring your thermostat" for details and Fig 3).

Step 4. Fix the mounting plate into the wall with screws in the box. See Fig 4.

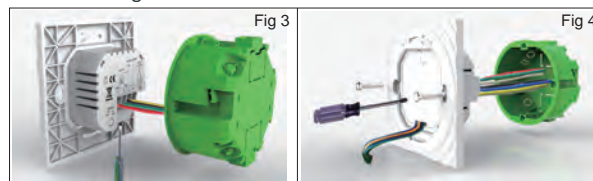

Step 5. Fasten body of thermostat and the mounting plate through rotating. See Fig 5.

Step 6. Installation complete. See Fig 6.

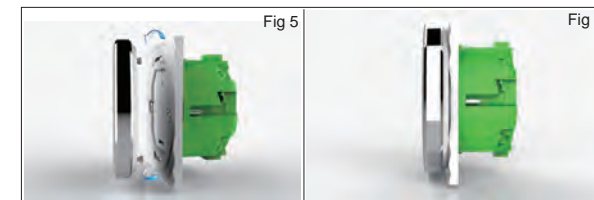

HOME SCREEN QUICK REFERENCE



- Monday To Sunday
- Room Temp.
- Set Temp.
- Floor Temp.
- Wifi
- Clock
- Manual
- Heating
- Time Display
- Timing On/Off
- Humidity
- C or F
- Period 1 to Period 6
- Room Temp. Display
- Heating On
- Down Button
- Up Button Mode
- Clock Button Mode
- Mode
- Power On/off

OPERATION

During Power On

- Power On/off:** Press to turn the thermostat on/off.
- Manual & Programmable**
Touch **M** (mode) to change between manual mode and programme mode. In manual mode, will show in the bottom left of the screen. In programmable mode, the period icon will show in the right side.
- Setting Temperature**
In the mode of programmable, set temperature, time could not be adjusted. If the user want to change, please go to manual mode or programmable mode.
In the mode of manual, press **A** to set the desired temperature.
- Adjusting/Setting the Clock**
Touch the icon to set minute, hour and weekday (1 = Monday, 2 = Tuesday etc.) by using the **A** arrows. Press once more to confirm and exit.
- Locking your Thermostat**
Press and hold the **A** for 5 seconds to lock/unlock your thermostat. In item 3 of high senior options, you can select full lock or half lock.
- Adjusting/setting the Program Schedules**
When Wi-Fi connection is made, your thermostat will automatically accept the program schedule made via the APP on your device (see below for detailed instructions) To set the program schedules through your thermostat (NOT via your smartphone/tablet) simply follow the instructions as below:
Please note: Setting the programme schedule through your thermostat can only be carried out if there is no Wi-Fi connection between your thermostat and smartphone/tablet.
Touch **M** to change between manual mode and programme mode. In manual mode, will show in the bottom left of the screen. In programme mode, touch and hold the icon until the weekday

schedule settings appear (1 2 3 4 5 will show along the top of the screen). Use the **A** and **V** arrows to adjust the on time.
 Press the icon and use the **A** and **V** arrows to set the off time (2nd period).
 Press the icon and use the **A** and **V** arrows to set the temp.
 Repeat this process for periods 3 and 5 6.
 Press the icon once more to enter the Saturday schedule settings (6 will show along the top of the screen).
 Repeat the above process to set the period and temp. and Sunday schedule.
 Press once more to confirm and exit.

Default settings for program schedule

Time display	WEEKDAY (MONDAY – FRIDAY) (1 2 3 4 5 shows on screen)		WEEKEND (SATURDAY) (6 shows on screen)		WEEKEND (SUNDAY) (7 shows on screen)	
	TIME	TEMPERATURE	TIME	TEMPERATURE	TIME	TEMPERATURE
Period 1	06:00	20 °C	06:00	20 °C	06:00	20 °C
Period 2	08:00	15 °C	08:00	20 °C	08:00	20 °C
Period 3	11:30	15 °C	11:30	20 °C	11:30	20 °C
Period 4	13:30	15 °C	13:30	20 °C	13:30	20 °C
Period 5	17:00	22 °C	17:00	20 °C	17:00	20 °C
Period 6	22:00	15 °C	22:00	15 °C	22:00	15 °C

A separate schedule may be set for weekdays (Mon – Fri) and for weekends (Sat or Sun).

7. Checking the Temperature of Floor Sensor

Press and hold the **V** arrow for 5 seconds to display the temp. of floor sensor.

8. Return To Factory Default

Press the **Restore Manufacturer Defaults**, you can reset thermostat.

Steps: Open your app - go into your room - click menu on the top right corner - move to the end - Press **Restore Manufacturer Defaults**.

During Power Off

Setting the Functions and Options

When power is off, press and hold **M** and at the same time for 5 sec. in order to reach system function. Then press **M** to scroll through the available functions, and use the **A** and **V** arrows to change the available options. All settings are confirmed automatically.

Code	Function	Setting and options	Default
1	Temperature compensation	-7 to + 9 °C (for internal sensor)	-1
2	Deadzone Temperature	1 ~ 5 °C	1
3	Button locking	00: All buttons are locked except power button. 01: All buttons are locked.	01
4	Sensor types	In: Internal Sensor (to control the temp.) Ou: Only external sensor (to control the temp.) AL: Internal/ External Sensor (Internal sensor to control the temp., external sensor to limit the temp.)	AL
5	Min. Set Temp.	5-15 °C	05
6	Max. Set Temp.	15-45 °C	35
7	Display Mode	00: Display both settemp. and room temp. 01: Display settemp. only	00
8	Low temperature protection setting.	0-10 °C	00
9	High temperature protection setting.	25-70 °C	45
A	Economy Mode	00: Non-energy saving Mode 01: Energy saving mode	0
B	Economy Temp.	0-30 °C	20
C	Standby Brightness	3-99	04

ABOUT WIFI

WI-FI CONNECTION

Before using your Wi-Fi thermostat for the first time, you must configure the Wi-Fi signal and settings through your smartphone or tablet. This will allow communication between your connected devices.

Step 1 Download your APP (Fig1-1)



Fig 1-1



Fig 1-2 IOS



Fig 1-3 Android

Search for "Smartlife" in Apple Store or Google Play or use a browser to scan the QR code above (Figure 1-2), and complete account registration and installation according to the guidance of the APP.

Step 2. Connect the thermostat

Check the tutorial below to complete the connection and setup.

Method 1: Scan the QR code to configure the network guide (Fig 2.1-Fig 2.3)



Fig2.1

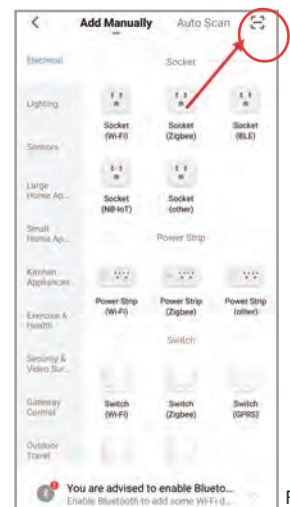

Fig2.2



Scan this QR code

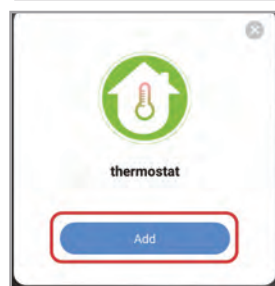

Fig2.3

Method 2: Ordinary distribution network guidance (Fig. 2. 1&Fig. 2.3.1)



Fig2.3.1



Fig2.5



Fig2.7

Network distribution mode:

1、EZ Mode

When the thermostat is off, press and hold the "▼" until the thermostat screen flashes quickly and displays the "📶" icon, and then operate according to the following figure (Fig 2.4-Fig 2.7).

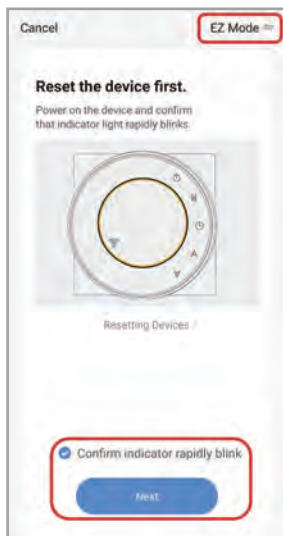

Fig2.4

2、AP Mode

When the thermostat is off, press and hold the "▼" until the thermostat screen flashes slowly and the "📶" icon is displayed (if the "📶" icon appears, continue to press the "▼" until the thermostat screen flashes slowly and displays the "📶" icon), and then operate according to the following figure (Fig 2.8-Fig 2.14).

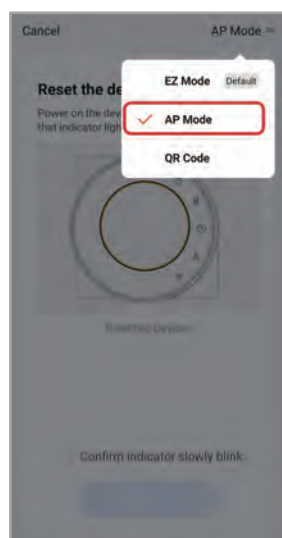

Fig2.8

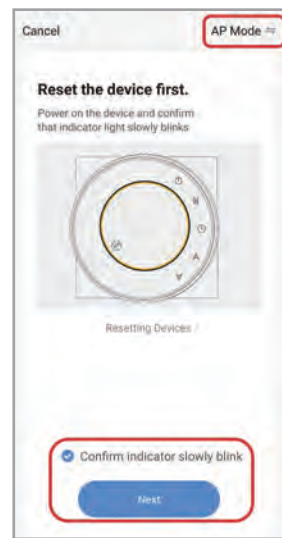

Fig2.9

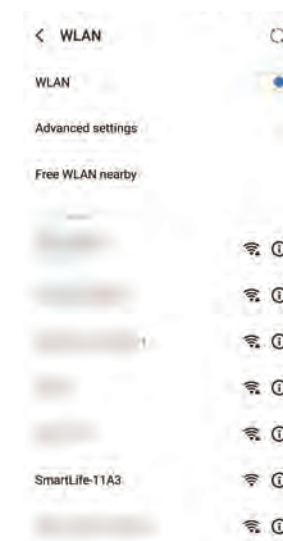

Fig2.12

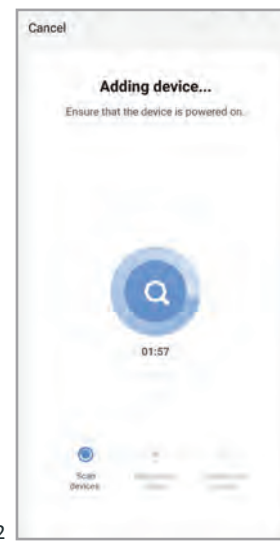

Fig2.13

After connecting to this hotspot, return to the "smartlife" APP

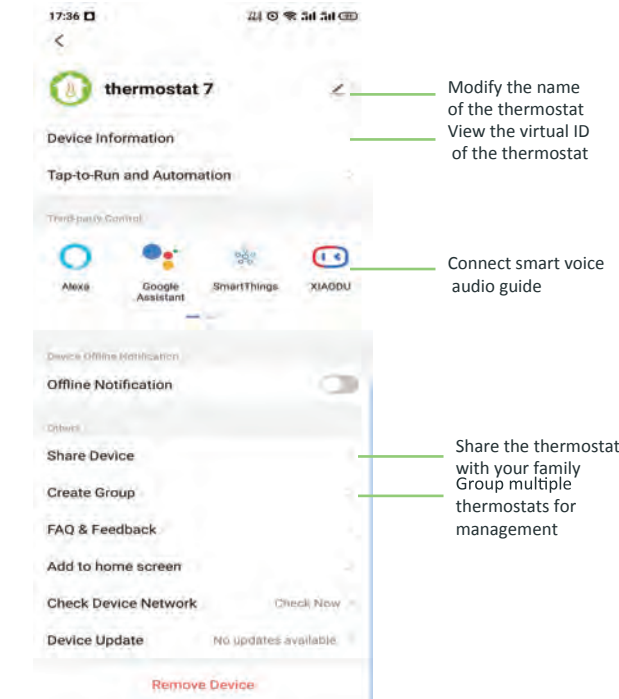

Fig2.14

APP operation interface description (heating thermostat)



More settings



SIMPLE EXCEPTION HANDLING

No.	Phenomenons	Handling
1	Power is on but without display.	*Check if the terminals between LCD panel and Power Unit Box is loosen.
2	Without output but display works.	* Use a new LC panel or new Power Unit Box to replace the old one.
3	Room Temp. is a little different from the actual.	* Do temperature calibration in item 1 of high senior options

SERVICE

Your thermostat carries an 24 months warranty from date of purchase. Service outwith the warranty period may incur a charge. More detail please contact with us directly.